



MODEL LS050
BELT-DRIVE OR CHAIN-DRIVE
GARAGE DOOR OPERATOR

LINEAR LLC
(760) 438-7000
USA & Canada (800) 835-5666 & (800) 421-1587
Toll Free FAX (800) 468-1340
www.linearcorp.com

INSTALLATION INSTRUCTIONS

For Sectional and Jamb Type Doors

IMPORTANT SAFETY NOTES

Please read the instructions carefully! This garage door operator is designed to provide safe and reliable service if installed and tested as described in these instructions. A garage door is the largest mechanical appliance in a residence. Care must be taken to prevent injury or death during installation and operation of the garage door and garage door operator.

THE FOLLOWING FORMATS ARE USED FOR SAFETY NOTES IN THESE INSTRUCTIONS.

WARNING
This type of warning note is used to indicate possible mechanical hazards that may cause serious injuries or death.

WARNING
This type of warning note is used to indicate possible electrical shock hazards that may cause serious injuries or death.

CAUTION
This type of warning note is used to indicate the possibility of damage to the garage door or garage door operator.

IMPORTANT INSTALLATION SAFETY INSTRUCTIONS

WARNING
TO REDUCE THE RISK OF SEVERE INJURY OR DEATH TO PERSONS, REVIEW THESE INSTALLATION SAFETY STEPS BEFORE PROCEEDING

- 1 READ AND FOLLOW ALL INSTALLATION INSTRUCTIONS.
- 2 Install only on a properly balanced garage door. An improperly balanced door could result in severe injury or death. Repairs to cables, spring assemblies, and other hardware must be made by a qualified service person before installing the operator.
- 3 Disable all locks and remove all ropes connected to the garage door before installing the operator. Ropes connected to a garage door can cause entanglement and death.
- 4 If possible, install door operator 7 feet or more above the floor with the manual release handle mounted 6 feet above the floor.
- 5 Do not connect the operator to the power source until instructed to do so.
- 6 Locate the wall station within sight of the door at a minimum height of 5 feet so that small children cannot reach it. Locate the wall station away from all moving parts of the door.
- 7 Install the User Safety Label on the wall adjacent to the wall station.
- 8 Upon completion of the installation, the door must reverse when it comes in contact with a 1-1/2" high object (or a 2x4 laid flat at the center of the door) on the floor and when the infrared safety beam is blocked.
- 9 Do not wear watches, rings or loose clothing while installing or servicing an operator. Jewelry or loose clothing can be caught in the mechanism of the garage door or the operator.
- 10 DISCONNECT THE ELECTRIC POWER FROM THE GARAGE DOOR OPERATOR BEFORE MAKING ANY REPAIRS OR REMOVING THE COVER.

1 Check the Door Balance

- 1 From outside the garage, slowly open the door all the way, and then close it all the way. Notice if there is any binding, sticking or rubbing. The door should move smoothly in both directions.
 - 2 Raise the garage door about halfway up. Carefully release the door and see if the door balances. It should stay in place. Close the door.
- IMPORTANT:** If the garage door is unbalanced or the door travel isn't smooth, have a qualified garage door professional adjust or repair the door.

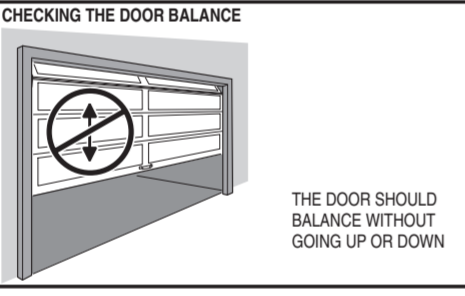

2 Attach the Rail to the Operator

- 1 Place the operator head on the garage floor with cardboard underneath it to protect the finish.
- NOTE:** To prevent upsetting the pre-adjusted door limits in the operator, keep the trolley at the same place on the rail until the sprocket is on the drive shaft.
- 2 Align the rail over the center of the operator head.
- 3 Be sure the flat on the sprocket lines up with the flat on the drive shaft.
- 4 Slide the sprocket onto the shaft.
- 5 Attach the rail to the operator head by installing four 1/4-20 x 3/4" bolts.
- 6 Tighten the four bolts in the order shown with a 7/16" socket.

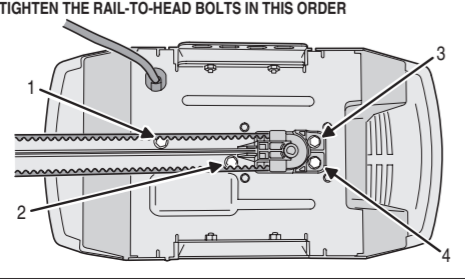
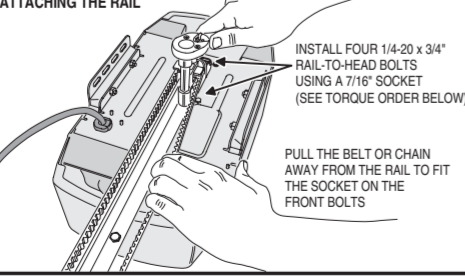
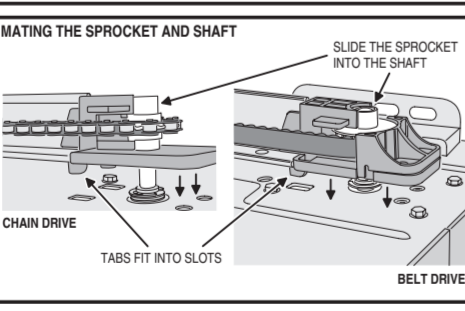
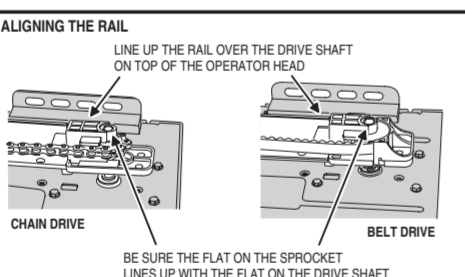

CAUTION
- BELT RAILS HB77 ONLY! -
TURN THE OPERATOR'S OPEN LIMIT 4 TURNS IN THE DOWN DIRECTION BEFORE OPERATING UNIT.

3 Locate the Header Bracket Position

- 1 Check whether door is a sectional or one-piece jamb type. Note the differences in mounting header bracket, door arm assembly and hanging the operator.
 - 2 Close the door.
 - 3 From inside the garage, use a pencil to mark the vertical centerline of the door on the header wall and on the top panel of a sectional door or on the top edge of a jamb door.
 - 4 Examine the area above the center of the door on the door header wall for a header bracket mounting location.
 - 5 Open the door to the high-rise point (the point where the top edge of the door is highest above the floor) and measure the distance to the floor.
 - 6 Close the door and use a pencil to mark the header wall 1" above (sectional) or 7" above (jamb) the measured high-rise point.
- NOTE:** In some installations, the header bracket location will be higher than the door header. This will require adding a 2x4 (or larger) cross piece to the wall studs to provide a mounting location for the header bracket. Use lag screws (not supplied) to attach the 2x4 to the studs.
- 7 On sectional doors with low headroom, the header bracket can be attached to the ceiling up to 6" back from the header wall (see next step).

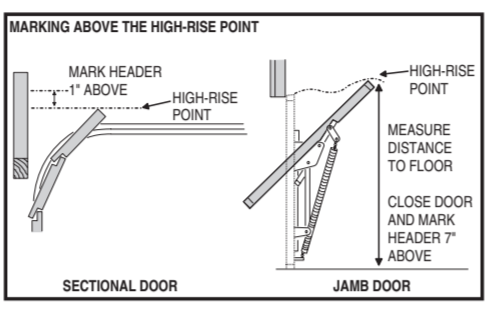
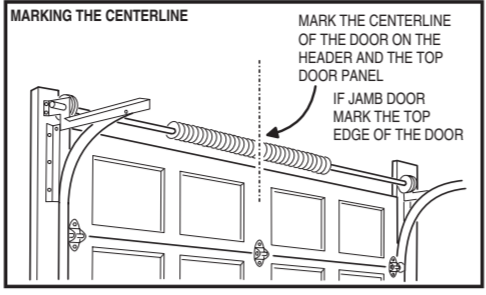

4 Install the Header Bracket

Attaching the Header Bracket to the Wall

- 1 Hold the header bracket on the center line drawn above the door with the bottom edge of the bracket on the line marked above the high-rise point.
- 2 Use a pencil to mark the two bracket holes.
- 3 Drill two 3/16" pilot holes about 2" deep.
- 4 Use a 1/2" socket to fasten the bracket with two 5/16" x 2" lag screws.

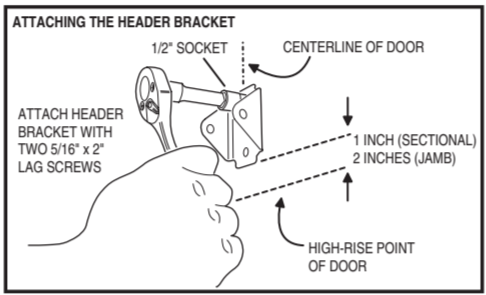

Attaching the Header Bracket to the Ceiling

NOTE: On a finished ceiling, be sure there is a joist to fasten to under the sheetrock where the header bracket will be located (use a stud finder). If there is none, install a 2x4 cross piece between the two closest joists to fasten the header bracket onto.

- 1 Extend the center line drawn on the header wall along the ceiling.
- 2 Hold the bracket on the center line with the edge of the bracket no further than 6" from the header wall.
- 3 Use a pencil to mark the two bracket holes.
- 4 Drill two 3/16" pilot holes about 2" deep.
- 5 Use a 1/2" socket to fasten the bracket with two 5/16" x 2" lag screws.

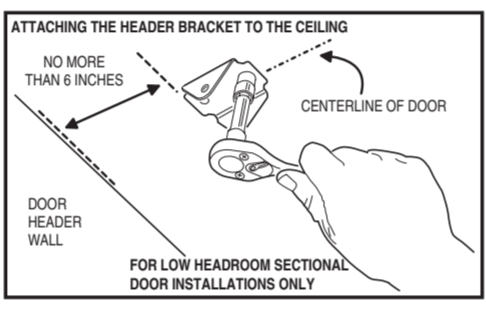

5 Connect the Rail to the Header Bracket

- 1 Place assembled operator on the empty carton on the floor with rail towards the door.
- 2 Insert the end of the rail into header bracket.
- 3 Insert the 5/16" x 2-3/8" clevis pin through header bracket and rail.
- 4 Secure the clevis pin with the hitch pin.

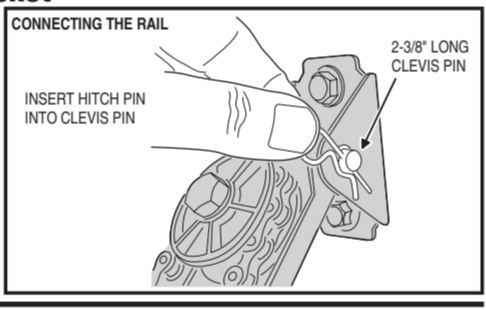

6 Hang the Operator

Installation requirements vary with garage construction. Hanging brackets should be angled to provide rigid support. Hanging material is not provided. Angle iron and lag screws are recommended. DO NOT USE NAILS. Following are typical operator hanging methods. Certain installations will require improvised methods.

- 1 Raise the operator head and set it on top of a stepladder (use extra spacers on top of ladder if it isn't tall enough).
- 2 SECTIONAL DOORS: Carefully open the door to the full up position. Lay a 2x4 across the top section of the door as a spacer. Adjust the operator height until the rail touches the spacer. The rail should be close to level.
- 3 JAMB DOORS: Carefully open the door to the high-rise point. Adjust the operator height until the rail is 2" above the door high-rise point. The rail should angle up towards the header wall.
- 4 For finished ceilings only: An angle iron cross piece between the two closest joists above the operator will be required. Mark mounting hole locations, drill pilot holes and attach the piece with two lag screws (not supplied).
- 5 Measure the distance from each of the operator's hanging tabs to the ceiling joists or angle iron cross piece.
- 6 Cut two angle iron pieces to the required lengths for hanging brackets. Bend brackets if required.
 - For unfinished ceilings: Hold each bracket in place and use a pencil to mark the locations where they will be attached to the joists, drill pilot holes and attach the pieces with two lag screws (not supplied).
 - For finished ceilings with an angle iron cross piece: Attach the two hanging brackets to the cross piece with two bolts and two keps nuts (not supplied).
- 7 Attach operator to hanging brackets using two 5/16-18 x 1" hex bolts and two 5/16-18 keps nuts (supplied). Insert bolts from the inside of hanger brackets with the nuts on the outside of the operator. Tighten nuts with a 1/2" socket.
- 8 Tighten all hanging hardware.
- 9 Open and close the door manually. The door should clear the rail by at least 1".
- 10 Attach the trolley's release lever to the red release handle with the cord supplied so the handle is at least 6 feet from the floor. Cut off any excess cord.
- 11 Press the light cover release tabs in to open the covers. Install two 100 watt maximum rough service lamps. Swing the light covers closed, snapping them shut.

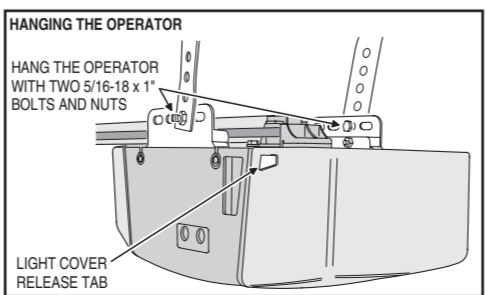
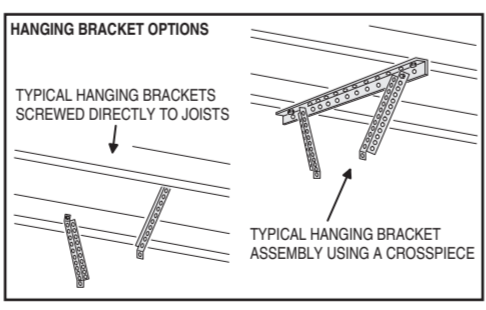
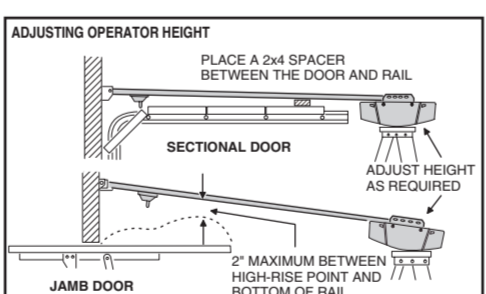
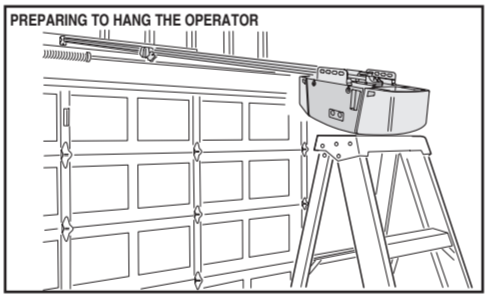

7 Install the Wall Station

WARNING
Children operating or playing with a garage door operator can injure themselves or others. The garage door could cause serious injury or death. Do not allow children to operate the remote control(s) or the wall station. Install the wall station out of reach of children and away from all moving parts of the door. The door must be clearly visible from the wall station. A moving garage door could injure someone under it. Only activate the door when it is properly adjusted, when it can be seen clearly and when there are no obstructions to the door travel.

- NOTE:** 22 AWG 2-conductor wall station and safety beam wire is supplied with the operator. Use this wire or the installation's pre-wiring. For additional wire, contact Linear for information regarding the 24-pack Model HAE00009 wire and wire clip kit.
- UL NOTE:** All low voltage Class 2 cable used with this operator must be UL Listed Type CL2, CL2P, CL2R, or CL2X or other cable with equivalent or better electrical, mechanical, and flammability ratings.

- 1 Strip back 1/2" of insulation and connect a wire to each of the two terminals on the back of the wall station.
- 2 Use the screws provided to mount the wall station near an access door at a minimum height of five feet. SEE IMPORTANT WARNING ABOVE!

- 3 For non-prewired installations, route the wire to the back of the operator. Use insulated staples (not supplied) to secure the wire. Staples must straddle both wires to avoid electrical shorts.
 - 4 Cut the wall station wire about 6" longer than needed to reach the operator terminals. Strip back 1/2" of insulation.
 - 5 Connect either wire to the operator's PUSHBUTTON terminal and the other wire to the operator's COMMON terminal.
 - 6 Apply the User Safety Instruction Label to the wall next to the wall station. Use staples or tacks to help the label remain in place over time.
- IMPORTANT! DO NOT PLUG THE OPERATOR IN AT THIS TIME! More installation is required.**

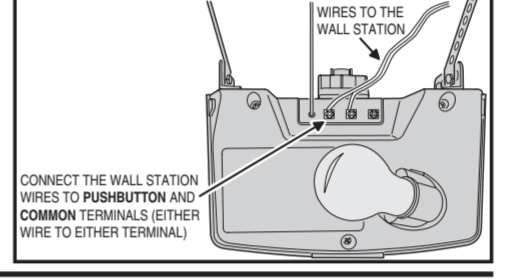
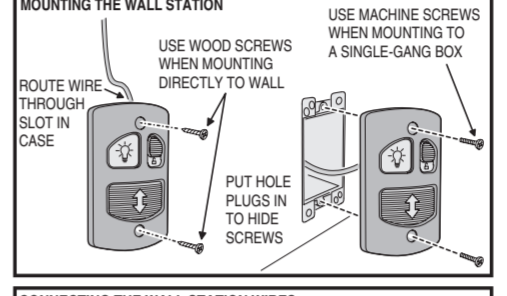
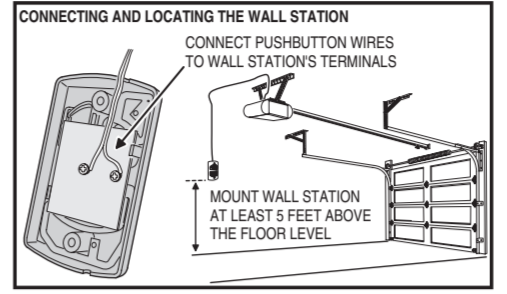

8 Install the Safety Beam

WARNING
Persons, particularly children, could be killed by a closing garage door without a properly installed and adjusted safety beam optical obstacle sensing system.

- NOTE:** The safety beam's infrared light beam must not be obstructed by the door, or by any part of the door hardware. Use wooden spacers between the beam brackets and wall if necessary to create proper clearance.

- 1 Assemble the two safety beam brackets from the four L-shaped brackets using two 1/4-20 x 3/4" bolts and 1/4-20 keps nuts (one nut & bolt for each bracket).

WARNING
To protect small children, do not install the safety beam higher or lower than instructed.

- 2 Position the assembled brackets on each side of the door so the center line of the safety beam lenses will be 6" above the floor. Use the index marks on the brackets to make the bracket assemblies equal lengths. Mark the locations for the bracket mounting screws (the brackets can be wall or floor mounted).

- NOTE:** The safety beam receiver (the unit with two indicators) should be located on the "shady" side of the door to prevent sunlight from shining directly into the receiver's lens.

- 3 Drill two 3/16" pilot holes for lag screws at marks. Mount the brackets with two 1/4" x 1-1/4" lag screws and tighten with a 7/16" socket (or use proper concrete fasteners if floor mounting).

- 4 Insert the sender and receiver into the bracket holes so the lenses of the units will face each other. Twist the units until the spring clips lock into a detent mark on the brackets. To protect the units from being bumped after installation, it is recommended to mount the sender and receiver inside the brackets as shown.

- IMPORTANT:** Be careful to route the safety beam wiring away from any moving parts of the door or operator.

- 5 For non-prewired installations, route the wires from the sender and receiver, up the wall above the door hardware, then over to the center of the door, then along the top of the rail (or ceiling), and back to the operator head. Cut the wires about 6" longer than needed to reach the operator terminals. Strip back 1/2" of insulation from the ends of the wires.

- 6 For non-prewired installations, secure all the wires to the wall and ceiling with insulated staples (not supplied). Staples must straddle both wires to prevent shorts. Secure the wire to the top of the rail with wire clips (supplied).

- 7 At the operator, twist one wire from each pair together, then twist the other wire from each pair together.

- 8 Attach either twisted connection to the operator's BEAM terminal. Connect the other twisted connection to the operator's COMMON terminal.

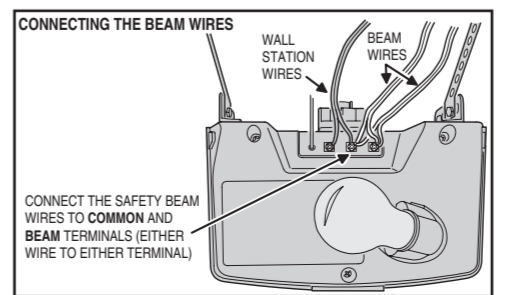
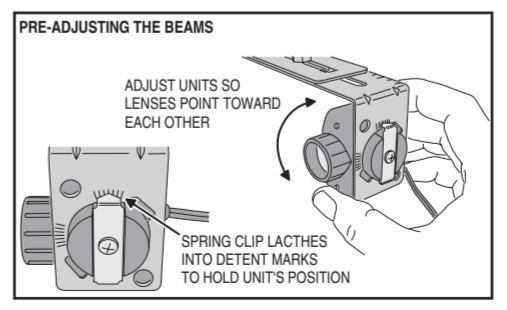
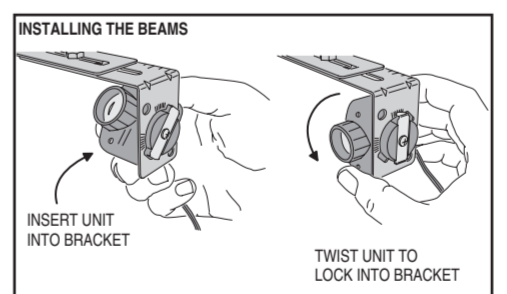
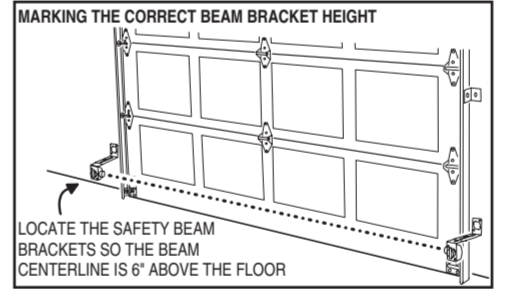
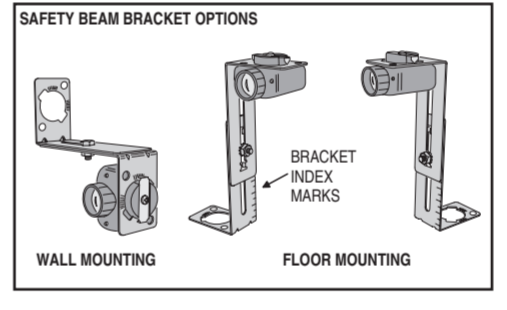
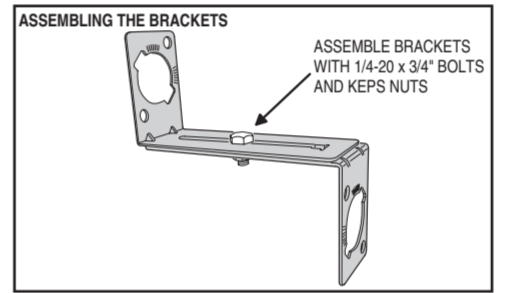

9 Install the Door Bracket and Door Arm

- SECTIONAL DOORS**
- 1 Fully close the door. Hold the door bracket against the inside of the door's top panel. Align the top edge of the bracket 2" to 4" below the top edge of the door; or, if there is a structural support across the top of the door, place the top edge of the bracket directly below the support. Align the vertical centerline drawn on the door with the center of the bracket. See the figure for details. Mark the left and right holes of the bracket.

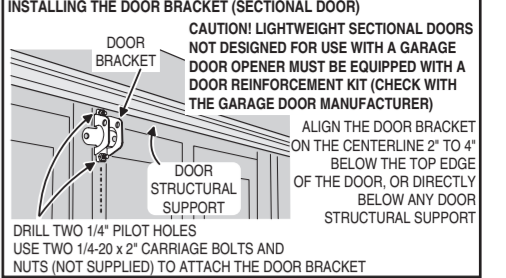

- 2 Drill 1/4" holes at marks and insert two 1/4-20 x 2" carriage bolts (not supplied) from outside of door through the door bracket.

- 3 Secure door bracket with two 1/4-20 keps nuts (not supplied). Tighten with a 7/16" socket.

- 4 Slide the 5/16" x 1-3/8" clevis pin through one hole on door bracket; then the other hole on the curved door arm; then through the single hole on the door bracket. Secure the clevis pin with the hitch pin.

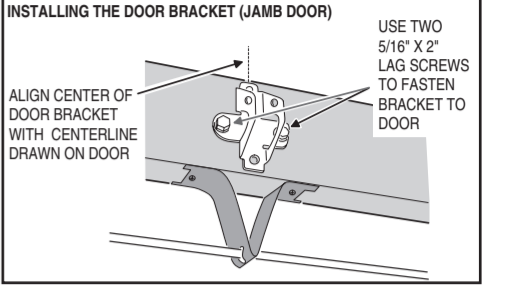

- 5 Insert the single hole end of the straight door arm into the slot in the trolley. Slide the 1-1/8" clevis pin through the hole and secure it with a hitch pin.

- 6 Flip the trolley release lever to disconnect the trolley.
- 7 Rotate the curved door arm upward to meet the straight door arm connected to the trolley. Align the two door arms so that the holes in both arms overlap.

- NOTE:** The straight door arm should be slightly angled toward the operator head.

- JAMB DOORS**
- 1 With the door fully open, hold the door bracket on the vertical centerline drawn on top edge of the door. Use a pencil to mark the four mounting holes of the bracket.

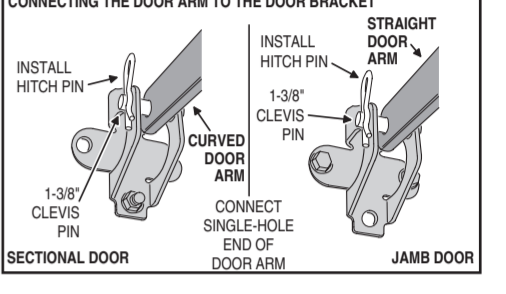

- 2 Drill 1/4" holes at marks and fasten the bracket with two 5/16" x 2" lag screws to the top of the door.
- 3 Slide the 5/16" x 1-3/8" clevis pin through one hole on door bracket; then the single hole on the straight door arm; then through the other hole on the door bracket. Secure the clevis pin with the hitch pin.

- 4 Insert the single hole end of the curved door arm into the slot in the trolley. Slide the 1-1/8" clevis pin through the hole and secure it with a hitch pin.

- 5 Flip the trolley release lever to disconnect the trolley.

- 6 Rotate the straight door arm upward to meet the curved door arm connected to the trolley. Align the two door arms so that the holes in both arms overlap.

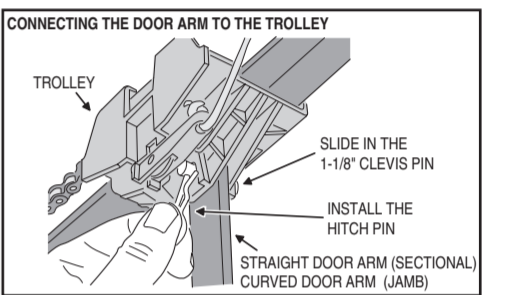

CONNECTING DOOR ARMS

- 1 Line up door arms until trolley is positioned as shown. Connect the arms together using two 5/16-18 x 1" bolts inserted in the highest and lowest matching holes, secure the bolts with two 5/16" keps nuts, tighten with a 1/2" socket.

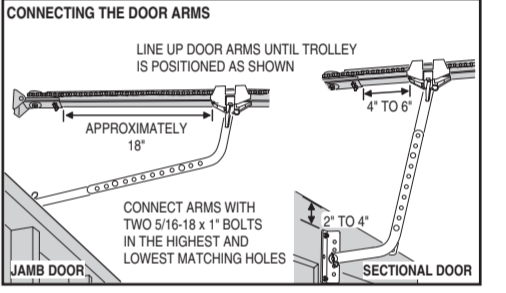

10 Connect the Operator to Power Source

WARNING
To prevent electrocution or fire, installation and wiring must be in compliance with local electrical and building codes.

Cord and Outlet Connection
The operator should be connected to a grounded receptacle on the ceiling or near the operator head. If none is available which will accept the grounded operator plug, one should be installed by a qualified electrician. Do not use an extension cord.

- 1 Plug the operator into a grounded receptacle.
- 2 When the operator is plugged in, a click should sound in the operator and the lights should turn on. If the lights do not turn on, check the power source and light bulbs.

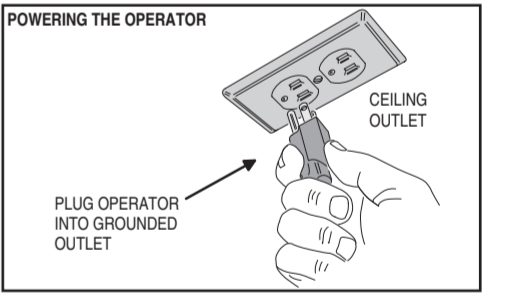

Permanent Wiring

SOME LOCAL ELECTRICAL CODES REQUIRE PERMANENT WIRING BETWEEN THE OPERATOR AND THE POWER SOURCE THROUGH A CONDUIT. IT IS RECOMMENDED THAT YOU HAVE A LICENSED ELECTRICAL CONTRACTOR FOLLOW THESE STEPS ONLY IF PERMANENT WIRING IS REQUIRED.

- 1 BE SURE POWER CORD IS UNPLUGGED.
- 2 Cut the power cord about 2" above the strain relief bushing on the operator.
- 3 Remove the four side screws and bottom cover of operator.
- 4 Use pliers to remove the strain relief bushing and discard the bushing.
- 5 Remove the outer insulation from the power cord and strip the white, black, and green wire insulation back about 1/2".
- 6 Pull white (neutral), black (hot) and green (ground) wires through conduit.
- 7 Connect the conduit to the operator with the appropriate termination.
- 8 Use wire nuts (not supplied) to connect the wires to the matching color wires inside operator head.
- 9 Secure the wires away from all moving parts with a zip-tie as shown in the figure.
- 10 Replace the operator cover and the four side screws.
- 11 Connect the conduit wires to the power source at junction box.
- 12 When power is applied to the operator, a click should sound and the lights should turn on. If the lights do not turn on, check the power source, wiring, and light bulbs.

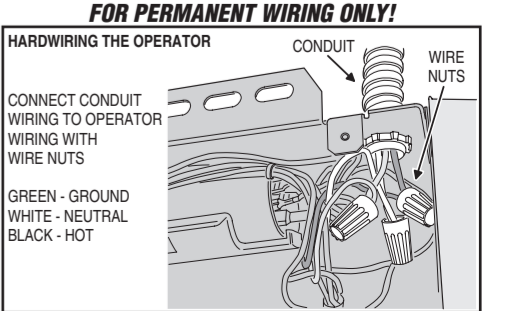
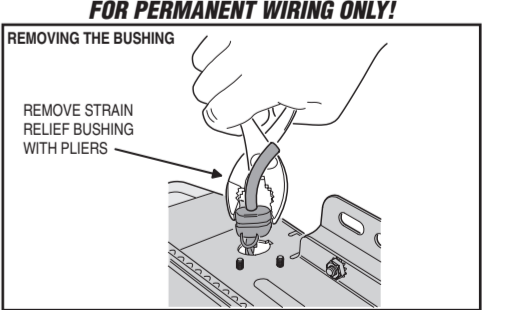
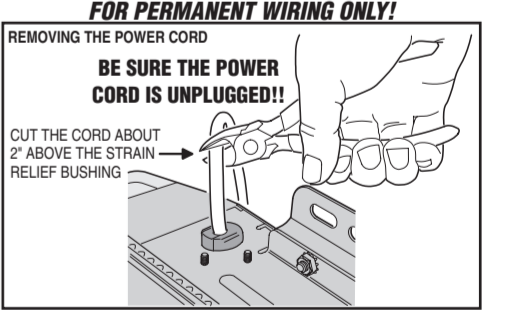

11 Aligning the Infrared Safety Beam

The safety beam has two components, a sender and a receiver. The sender produces a narrow infrared beam that travels across the bottom of the door opening to the infrared receiver. If an object blocks the infrared beam while the door is closing, the door will stop, then reverse and fully open (the operator's light will flash three times).

As a safety feature, the operator will ignore signals from all remote controls if the door is open and the infrared safety beam is blocked or out of alignment. In this case, the door can be forced closed by pressing and holding the wall station's up/down arrow pushbutton (be sure the door area is in clear view).

WARNING

With the door closed, disengage the trolley from the chain during these alignment tests by pulling the red release handle.

Safety Beam Test

- Check that the operator has power. The green lights on the sender and receiver should be lit.
- If the receiver's green light is on, but the red light is off, the receiver has power but is not detecting the infrared beam from the sender. The red light might flash when the beam is partially detected. This can be caused by mis-alignment or something blocking the beam. Adjust the safety beam sender and receiver while watching the receiver's red light (stay out of the beam while aligning it). When the red light stays on, the beam is aligned.

SAFETY BEAM INDICATOR TABLE	
GREEN ON	POWER ON
GREEN OFF	POWER OFF
RED ON	BEAM OK - NO BLOCKAGE
RED OFF	BEAM BLOCKED OR MIS-ALIGNED
RED FLASHING	BEAM ALIGNED POORLY

NOTE: If the receiver's red light remains off, check for: 1) Dirt on the receiver's lens, 2) Sunlight shining into the receiver's lens, 3) A short in the safety beam wiring (from staples or at the operator terminals).

With the door closed and the operator disengaged from the door, press the wall station's UP/DOWN ARROW button to move the traveler (the part on the belt or chain that the trolley engages with) to the up position (away from the door).

Push the wall station's UP/DOWN ARROW button again. While the traveler is moving to the down position (toward the door), block the safety beam. THE TRAVELER MUST STOP, THEN REVERSE TO THE UP POSITION. The operator's lights should flash three times.

Place an object in the path of the safety beam. Check that constant pressure is required on the wall station's UP/DOWN ARROW button to cause the traveler to move toward the down position. Release the pushbutton before the operator stops; check that the traveler returns to the up position.

NOTE: The garage door operator will not respond to a CLOSE command from a radio transmitter if the safety beam is blocked.

To reconnect the operator, flip the release lever up. Raise the door manually until the operator reconnects.

WARNING

Serious injury or death from a closing garage door may result because of failure to test and adjust safety reverse system. Repeat this test monthly and adjust as needed.

SAFETY BEAM INDICATORS

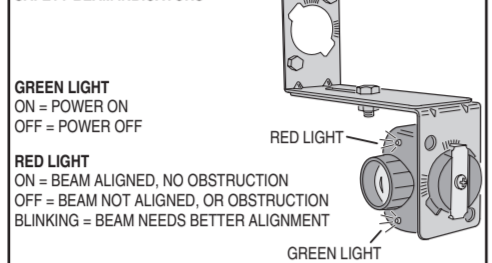

ADJUSTING THE BEAM

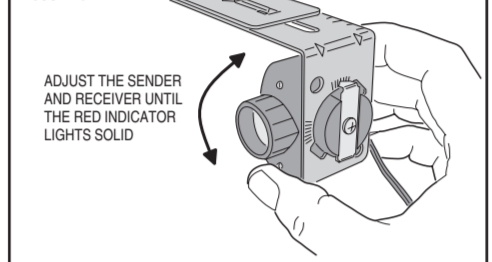

CHECKING FOR REVERSAL

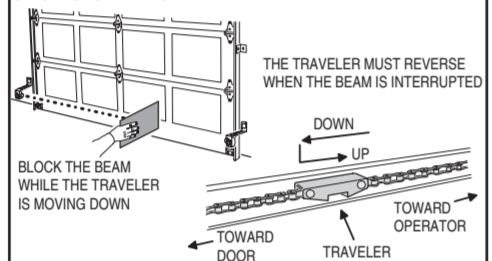

CHECKING FORCED CLOSURE FEATURE

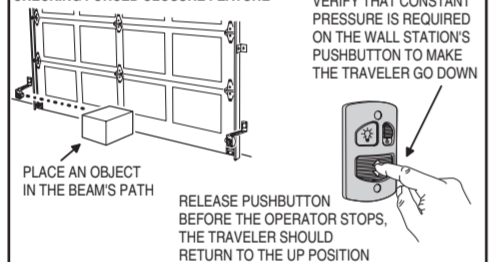

13 Adjusting the Open and Close Limits

The limit adjustments that control how far the door will open or close are located on the side of the operator. The limits should be adjusted so the door opens just short of any door stops, and closes right at the floor level. Each full turn of a limit adjustment equals about 2-1/2" of door travel.

CAUTION

Set the open and close limits carefully. Setting the limits beyond the distance that the door can travel could cause damage to the door, the door hardware, or operator.

If this is a jamb door installation, with the operator at mid-travel, turn the CLOSE LIMIT adjustment five turns in the UP direction before proceeding.

- Activate the remote control. Wait while the door moves to the open position and stops.
- Examine the position of the door.
 - If the door needs to open more, turn the OPEN LIMIT adjustment clockwise 1/4-turn (towards UP on the label) to raise the open limit.
 - If the door needs to open less, turn the OPEN LIMIT adjustment counterclockwise 1/4-turn (towards DOWN on the label) to lower the open limit.

NOTE: On jamb doors, set the open limit so the door stops just short of level (see figure).

- Activate the remote control. Wait for the door to move down a few feet, then activate the remote control again to stop the door.
- Repeat Steps 2-4 until the open limit is properly adjusted.
- Activate the remote control. Wait while the door moves to the closed position and stops.
- Examine the position of the door.
 - If the door needs to close more, turn the CLOSE LIMIT adjustment counterclockwise 1/4-turn (towards DOWN on the label) to lower the close limit.
 - If the door needs to close less, turn the CLOSE LIMIT adjustment clockwise 1/4-turn (towards UP on the label) to raise the close limit.

NOTE: If the door stops during opening or reverses during closing before reaching the limits, the door force adjustment needs to be set. Change the adjustment as described in the next section then return to this section to finish setting the limits.

- Activate the remote control. Wait for the door to move up a few feet, then activate the remote control again to stop the door.
- Repeat Steps 6-8 until the close limit is properly adjusted.

14 Testing & Adjusting the Door Force Safety System

The door force adjustments are located on the side of the operator. The door force adjustments must be properly set at all times. The CLOSE FORCE adjustment controls how much force is required to cause the door to reverse direction if an obstruction is encountered during closing. The OPEN FORCE adjustment controls how much force is required to stop the door if an obstruction is encountered during opening.

WARNING

Too much door force will interfere with the proper operation of the safety system. SOMEONE COULD BE SERIOUSLY INJURED OR KILLED IF THE DOOR FORCE IS SET TOO HIGH. A closing door might not reverse properly when required and someone could be pinned under it. An opening door might not stop when going up and someone hanging on the door could get pinned between the door and the header. Do not increase the door force beyond what is required to move the door. DO NOT USE THE DOOR FORCE ADJUSTMENT TO COMPENSATE FOR A BINDING OR STICKING GARAGE DOOR. PERFORM THE SAFETY REVERSAL SYSTEM TEST (STEPS 4-6) MONTHLY!

NOTE: Read the following directions carefully before setting the door force adjustments.

WARNING

Always perform the Door Force Safety System Test after making any adjustments to the operator.

Door Force Safety System Test

- Start with the door open. Use the remote control to cycle the door during these tests.
 - Adjusting the Close Force
- Turn the CLOSE FORCE adjustment 1/8-turn at a time in the DECREASE direction (counterclockwise) until the door stops and reverses mid travel while going down.
- Turn the CLOSE FORCE adjustment 1/8-turn at a time in the INCREASE direction (clockwise) until the door fully closes without reversing.

Safety Reversal System Test

- Lay a 2 x 4 board flat on the floor where it will be struck by the center of the door as it closes.
- Verify that the door reverses when it strikes the board. The door must reverse within two seconds after striking the board.
- NOTE: If the door stops after encountering the board and does not reverse, the CLOSE FORCE needs to be DECREASED.
- Repeat the Safety Reversal System Test until the door reverses within two seconds of striking the board.

Adjusting the Open Force

- Turn the OPEN FORCE adjustment 1/8-turn at a time in the DECREASE direction (counterclockwise) until the door stops mid travel while going up.
- Turn the OPEN FORCE adjustment 1/8-turn at a time in the INCREASE direction (clockwise) until the door fully opens without stopping.

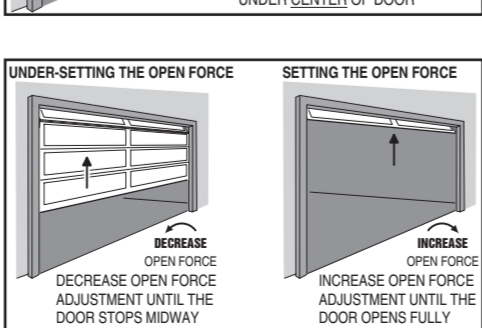
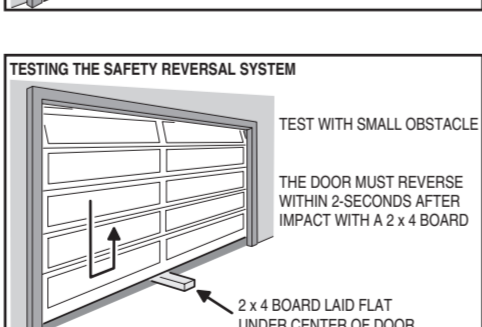
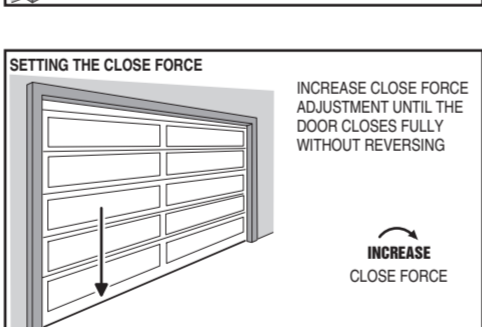
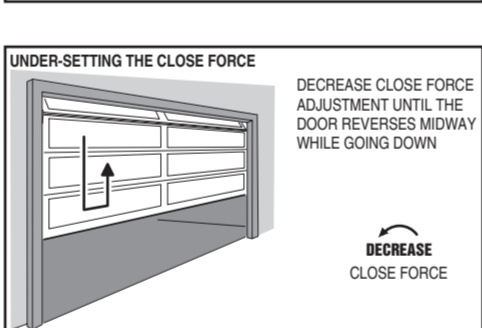
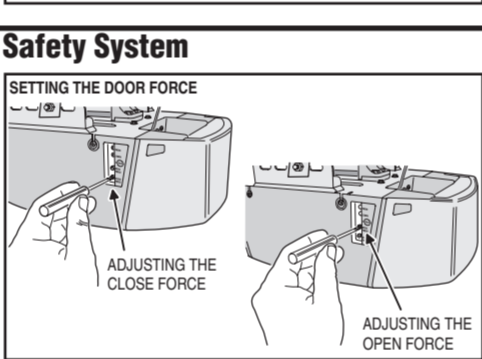
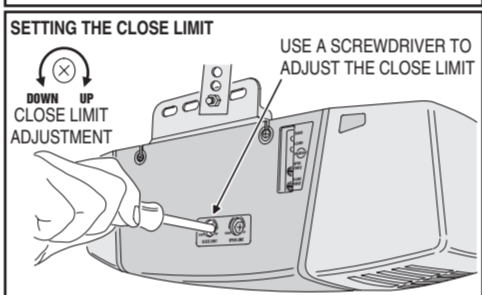
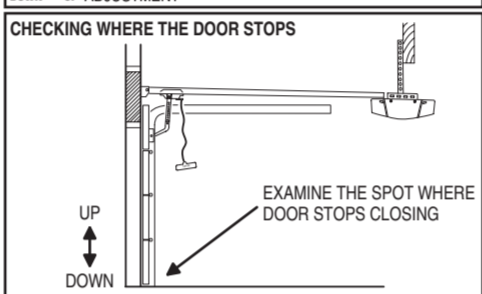
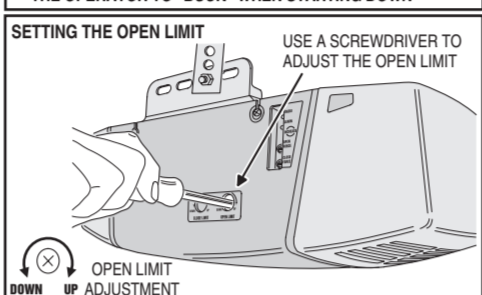
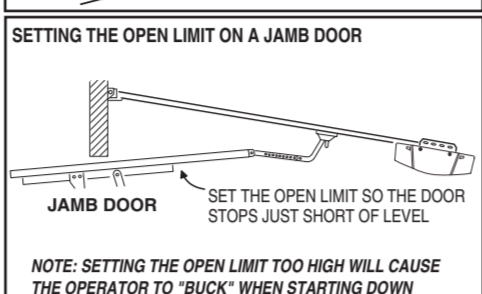
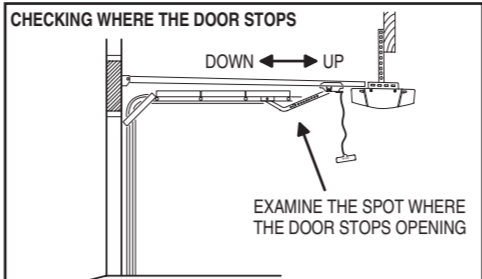

15 Using the Garage Door Operator

IMPORTANT USER SAFETY INSTRUCTIONS

WARNING

A MOVING GARAGE DOOR CAN CAUSE INJURY OR DEATH! TO REDUCE THE RISK OF DEATH OR SEVERE INJURY:

- READ AND FOLLOW ALL INSTALLATION INSTRUCTIONS.
- NEVER LET CHILDREN OPERATE, OR PLAY WITH DOOR CONTROLS! KEEP REMOTE CONTROL AWAY FROM CHILDREN!
- Always keep moving door in sight and away from people and objects until it is completely closed. NO ONE SHOULD CROSS THE PATH OF THE MOVING DOOR.
- NEVER GO UNDER A STOPPED, PARTIALLY OPEN DOOR.
- Test door operator monthly. The garage door MUST reverse on contact with a 1-1/2 inch object (or a 2x4 board laid flat at the center of the door) on the floor. If adjusting either the force or limit of travel, re-test the door operator. Failure to adjust the operator properly may cause severe injury or death.
- If possible, use the red emergency release handle only when the door is closed. Use caution when using this release with the door open. Weak or broken springs may cause the door to fall rapidly, causing injury or death.
- KEEP GARAGE DOORS PROPERLY BALANCED. (See Garage Door Operator Maintenance) An improperly balanced door could cause severe injury or death. Have a qualified service person make repairs to cables, spring assembly and other hardware.
- SAVE THESE INSTRUCTIONS.

Opening the Door

- With the door in view, press the wall station's UP/DOWN ARROW button or the button assigned to the operator on the remote control, or enter a valid access code and press START/STOP on a remote keypad.
- When the operator is activated, the operator's lights will turn on and the door will begin to open.
- The door will open until the open limit is reached. If an obstacle is encountered (operator's lights flash four times) while the door is opening, the door will stop.
- The operator's lights will stay on for about five minutes after the door stops.

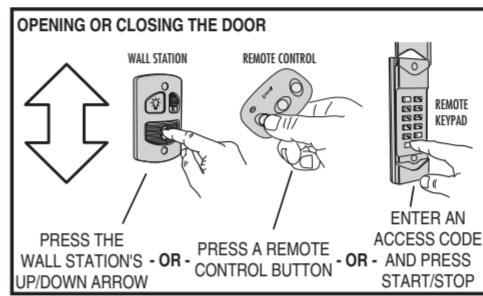

Closing the Door

- With the door in view, press the wall station's UP/DOWN ARROW button or the button assigned to the operator on the remote control, or enter a valid access code and press START/STOP on a remote keypad.
- When the operator is activated, the operator's lights will turn on and the door will begin to close.
- The door will close until the close limit is reached. If an obstacle is encountered (operator's lights flash four times), or the safety beam is interrupted (operator's lights flash three times) during closing, the door will stop, then re-open.
- The operator's lights will stay on for about five minutes after the door stops.

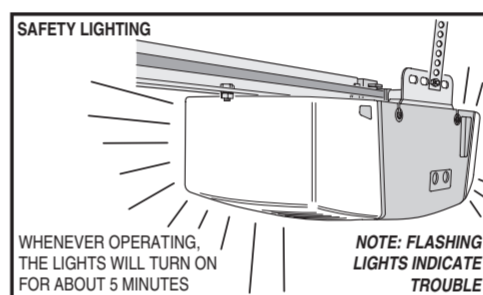

Stopping the Door Mid-travel

- The door can be stopped immediately at any time by pressing the wall station's UP/DOWN ARROW button, the remote control's pushbutton, or press the START/STOP button on a remote keypad.
- The next time the operator is activated, the door will move in the opposite direction.

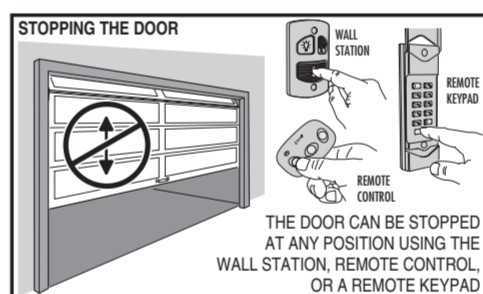

Vacation Lock for Additional Security

- Slide the wall station's LOCK switch to the locked position to prevent remote controls from opening the door after the door is completely closed. The remotes can close the door, but not open it. The door can still be opened or closed by using the wall station's UP/DOWN ARROW pushbutton.
- NOTE: To signal that the vacation switch is locked, the operator's lights will flash five times if a remote is activated in an attempt to open the door.
- Slide the wall station's LOCK switch to the unlocked position to return the operator to normal operation.

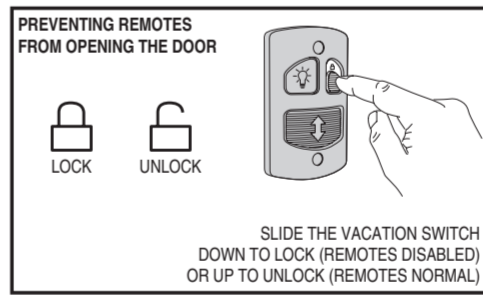

Controlling the Operator's Lights

- The operator's lights can be lit by pushing the wall station's LIGHT button. The lights will remain on until the LIGHT button is pressed again or the operator is cycled.
- If the operator's lights are on, pushing the wall station's LIGHT button will turn the operator's lights off.

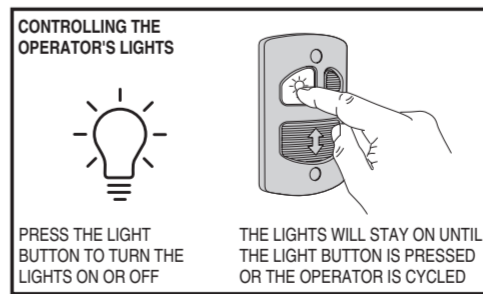

Disconnecting the Door from the Operator

- With the door in any position (preferably closed), carefully pull the red release handle. USE CAUTION IF THE DOOR IS OPEN, THE DOOR MAY DROP.
- The disconnected door can be opened or closed manually.
- To re-connect the operator, flip the release lever up. Raise or lower the door manually until the operator reconnects.

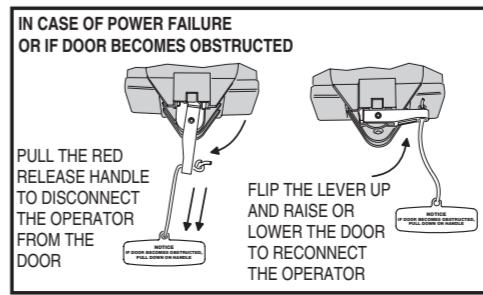

16 Garage Door Operator Maintenance

Weather conditions may affect the door operation which could require some re-setting of the operator's adjustments. Doors may swell and become heavier during wet periods, door hinges and rollers might bind during cold periods. To insure safe operation of the door, perform the following tests, including any additional test steps described.

Every Month

- With the door closed, pull the red release handle to disconnect the operator from the door.
- From outside the garage, slowly open the door manually all the way, and then close it all the way. Notice if there is any binding, sticking or rubbing. The door should move smoothly in both directions.
- Raise the garage door about halfway up. Carefully release the door and see if the door balances. It should stay in place. Close the door.

NOTE: If the garage door is unbalanced or the door travel isn't smooth, have a qualified garage door professional adjust or repair the door.

- To reconnect the operator, flip the release lever up. Raise the door manually until the operator reconnects.
- Perform the Safety Beam Test (Section 11).
- Perform the Safety Reversal System Test as described in Steps 4-6 in Section 14.

After Servicing the Operator

- Perform the Safety Beam Test (Section 11).
- Perform the Open and Close Limit Adjustments (Section 13).
- Perform the entire Door Force Safety System Test (Section 14).

Every 6 Months

Check the belt or chain tension.

- For belt-drive rails, examine the length of the tension spring in the traveler. It should be about 1" long.
- For chain-drive rails, examine the spacing between the turnbuckle and the rail. The turnbuckle should be slightly above the rail.

NOTE: Too much or too little chain tension will cause excessive sprocket noise.

Chain Adjustment

- Hold the turnbuckle with a flat blade screwdriver and loosen the two locknuts with a 7/16" end wrench.
- Twist the turnbuckle to adjust the chain tension. Adjust the chain until the turnbuckle is slightly above the rail.
- Hold the turnbuckle with a flat blade screwdriver and tighten the two locknuts with a 7/16" end wrench.

NOTE: FLASHING LIGHTS INDICATE TROUBLE

Belt Adjustment

- Hold the traveler so the adjustment wheel is visible through the large slot.
- Use a flat blade screwdriver to turn the adjustment wheel to compress the tension spring until its length is between .9" and 1" long.

Every Year

Check the door hardware for lubrication needs. Lubricate door hinges, rollers and bearings according to door manufacturer's recommended procedures.

WARNING

Garage door hardware (springs, cables, brackets, pulleys, etc.) are under extreme pressure and tension. DO NOT ATTEMPT TO LOOSEN, TIGHTEN OR ADJUST ANY DOOR HARDWARE. CALL A QUALIFIED GARAGE DOOR INSTALLATION PROFESSIONAL!

WARNING

The garage door operator must not be installed and used on an unbalanced door. The operator's internal door force sensor will not function properly on an unbalanced door. Risk of serious injury or death may result.

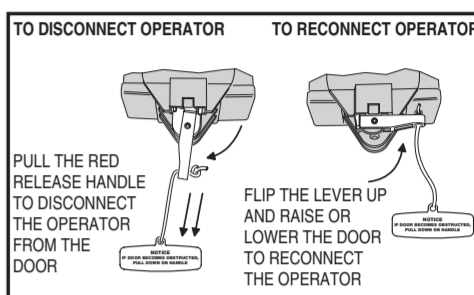

WARNING

Always perform the entire Door Force Safety System Test (see Section 14) after making any adjustments to the operator.

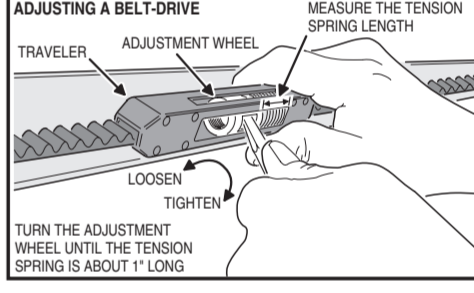
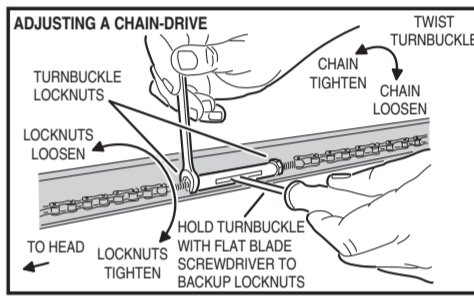

12 Remote Controls

The operator is supplied with a three-button remote control (the second and third buttons can be used to control an additional operator or gate if it contains a Linear MegaCode™ receiver). Additional single and multi-button remote controls can be purchased. An unlimited number of remote controls can be used with this operator. The short white wire on the back of the operator serves as an antenna for the remote controls. Do not cut off the white wire or the remote controls will not operate well.

WARNING

Children operating or playing with a garage door operator can injure themselves or others. The garage door could cause serious injury or death. Do not allow children to operate the remote control(s) or the wall station. A moving garage door could injure or kill someone under it. Activate the operator only when the door is clearly visible, free of obstructions and adjusted properly.

To Add or Remove a Remote Control

- Press the operator's LEARN button. The red LEARN light will glow. The red light will stay on for about 15 seconds. A remote must be added or removed while the red LEARN light is still on.
- Send a signal from a remote. The opener's light and the red light will flash once if a remote was added, or the opener's light and the red light will flash four times if a remote was removed.
- Repeat Steps 1 & 2 for any additional remote controls.

To Remove all Remote Controls

- Press and hold the operator's LEARN button for ten seconds or more.
- Release the LEARN button. The red LEARN light will blink three times signaling that all of the remotes in the operator's memory were erased. The red LEARN light will turn off, then turn on for 15 seconds. A remote control can be entered during this time using Step 2 above.

Testing

- Before testing the remote control, straighten out the operator's white antenna wire so it points up.
- Stand clear of the door, press the remote control's button and verify that the operator starts. PRESS THE REMOTE CONTROL'S BUTTON AGAIN TO STOP THE DOOR MID-TRAVEL.
- Set the open and close limits as described in the next section before any further testing.

Replacing a Remote Control's Batteries

When the red light on the remote glows dimly, or fails to light at all when the remote is activated, the batteries need replacing.

- Open the remote's case and remove the circuit board
- Replace old batteries with two Type 2032 batteries.
- Re-assemble the remote.

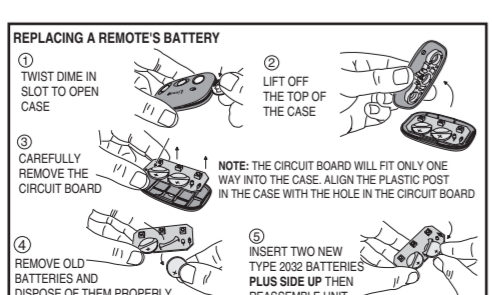
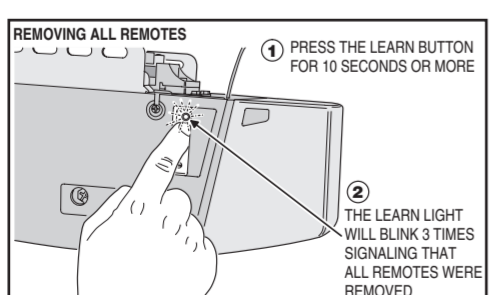
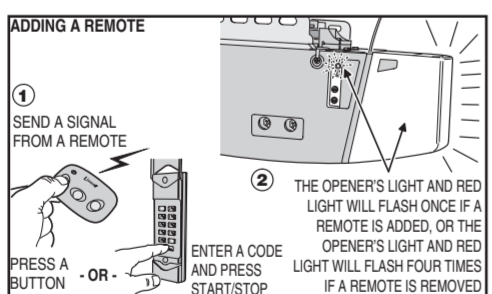
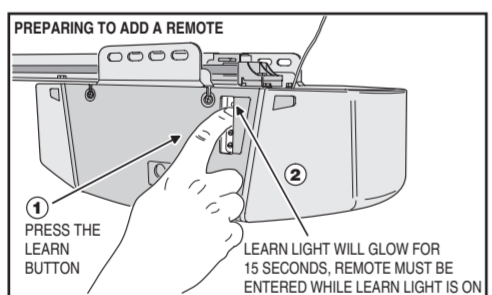

17 Troubleshooting

LAMPS FLASH TROUBLE CODE	PROBLEM	CAUSE	REMEDY
1 FLASH	No problem	Remote control entered into memory	Add any additional remote controls (MegaCode™ type only)
2 FLASHES	Door won't close	Shorted wall station wires	Check wall station wires. Be sure both are connected to the terminal screws. Check for a staple in the wall station wires. Remove any staples compressing the wire.
3 FLASHES	Door won't close	Safety beam obstacle	Check for obstacles. Align the safety beam (Section 11)
4 FLASHES	Door reverses or won't open or close	Open or Close force exceeded, or motor thermal shutdown	Check for binding or un-balanced door. Adjust the door force (Section 14). If motor had thermal shutdown, wait 30 minutes and retry.
5 FLASHES	Door won't open from transmitter	Remote was activated while vacation switch was locked	Unlock vacation switch on wall station
6 FLASHES	Motor ran longer than 30 seconds	Mechanical or electronic failure	Call Technical Services Group for assistance

FCC NOTICE

Changes or modifications not expressly described in this manual or approved by the manufacturer could void the user's authority to operate the equipment.

This equipment has been tested and found to comply with the limits for a Class B digital device, pursuant to Part 15 of the FCC Rules. These limits are designed to provide reasonable protection against harmful interference in a residential installation. This equipment generates, uses and can radiate radio frequency energy and, if not installed and used in accordance with the instructions, may cause harmful interference to radio communications. However, there is no guarantee that interference will not occur in a particular installation. If this equipment does cause harmful interference to radio or television reception, which can be determined by turning the equipment off and on, the user is encouraged to try to correct the interference by one or more of the following measures:

- Reorient or relocate the receiving antenna.
- Increase the separation between the equipment and receiver.
- Connect the equipment into an outlet on a circuit different from that to which the receiver is connected.
- Consult the dealer or an experienced radio/TV technician for help.

LIMITED WARRANTY

This Linear product is warranted to the original consumer against defects in material and workmanship for:

MODEL LS050	ELECTRONICS 1 year	MECHANICAL 5 years	MOTOR Lifetime	BELT Lifetime
This product is warranted to the original consumer against defects in material and workmanship for the periods mentioned above. Linear will repair, or at its option, replace, any device that it finds requires service under this warranty, and will return the repaired or replaced device to the consumer at Linear's cost. Devices must be sent to Linear for service at owner's expense. This warranty does not apply to damage to the product from negligence, abuse, abnormal usage, misuse, accidents, normal wear or tear or due to failure to follow Seller's instructions, or arising from improper installation, storage or maintenance. In no event will Linear be responsible for incidental, compensatory, punitive, consequential, indirect, special or other damages. The remedies provided by this warranty are exclusive. Some states do not allow the exclusion or limitation of incidental and consequential damages, so the above limitation or exclusion may not apply to you. Any warranties implied by law are limited to the time periods set forth above. Some states do not allow limitations on how long an implied warranty lasts, so the above limitation may not apply to you. This warranty gives you specific legal rights, and you may also have other rights which vary from state to state.				
For warranty service and shipping instructions contact Linear at the phone number shown below. In order to be protected by this warranty, save your proof of purchase and send a copy with equipment should repair be required. All products returned for warranty service require a Return Product Authorization Number (RPA#). Contact Linear Technical Services at 1-800-421-1587 for an RPA# and other important details.				